

E100 First Fix

An easy fit installed music system

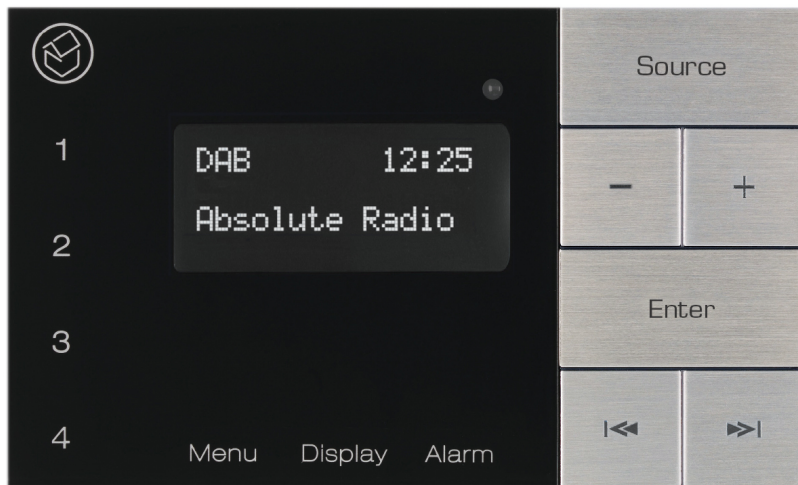

Pack Contents

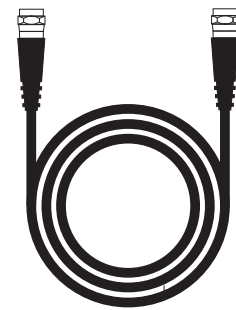

Antenna Extension Cable x 1

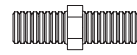

Antenna Adaptor x1

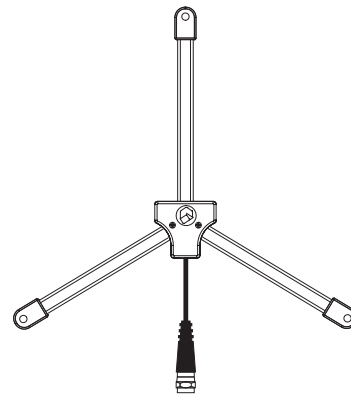

DAB/FM Antenna x 1



7m Speaker Cable x 2
(IMO speaker cable connectors supplied in second fix kit)

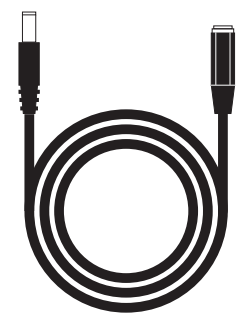

Power Supply Extension Cable x 1

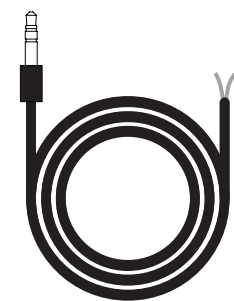

*3.5mm Jack Cable x 1
(optional)

*Not supplied

1. Planning E100 Positioning and Back Box Locations

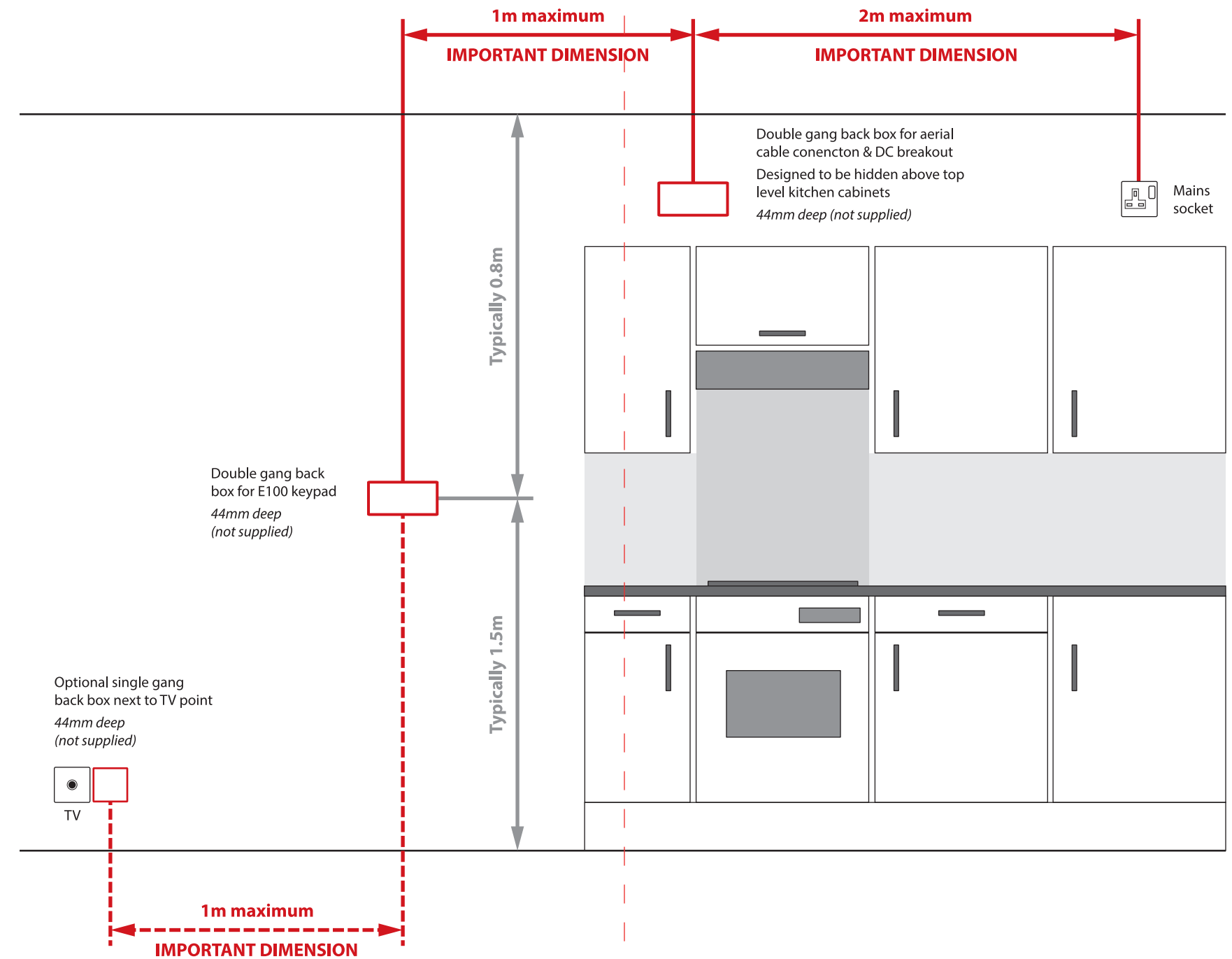

2. First Fix Wiring

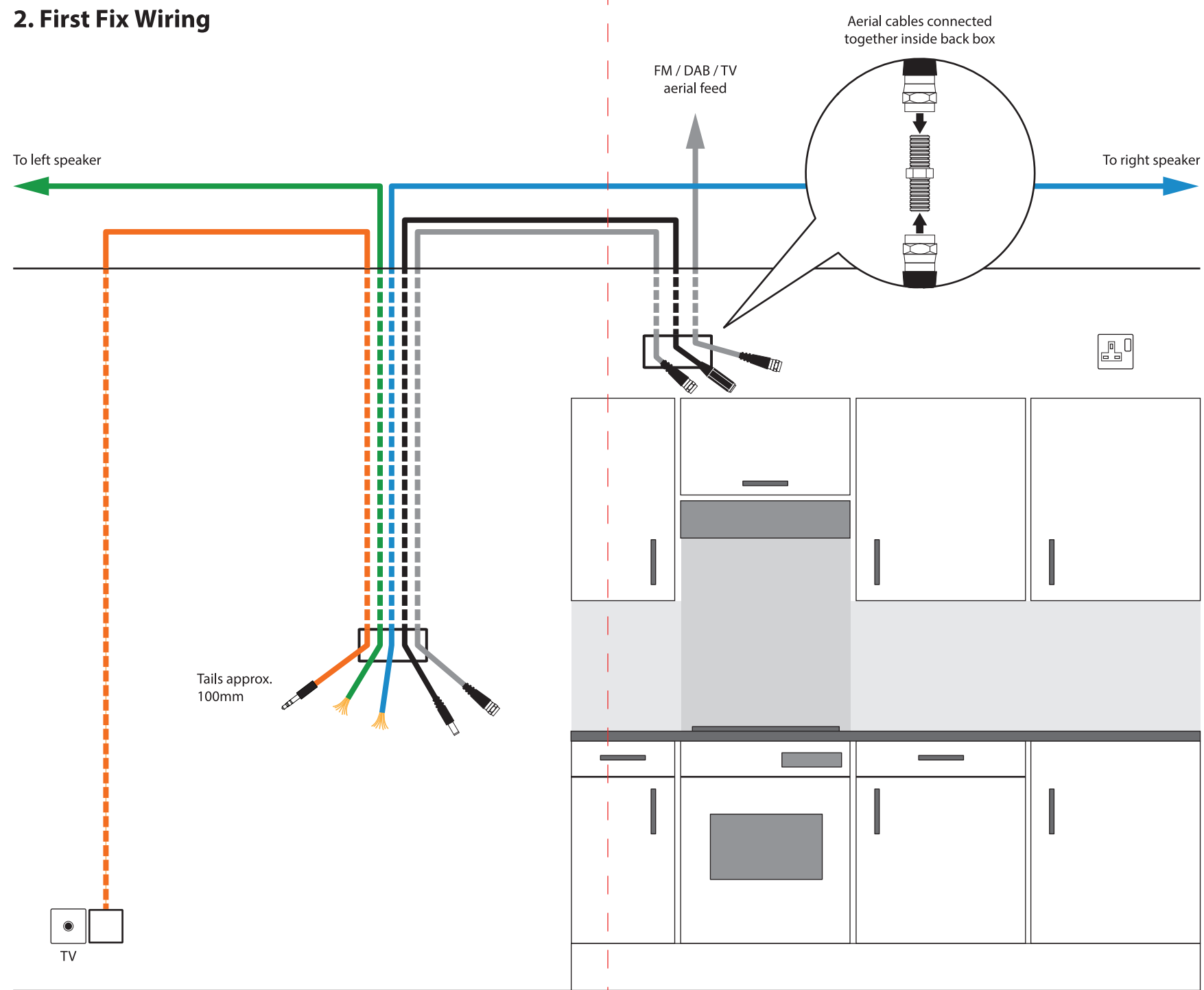

NOTES

1. Switched mains socket required next to cable break-out box
2. FM/DAB/TV aerial cable feed positioned next to cable break-out box
3. Single gang back-box required next to TV aerial point for optional TV sound / AUX input

KEY

- Aerial cable
- Terminated DC power cable
- Speaker cable (left)
- Speaker cable (right)
- Line-in cable (pre-terminated one end)

E100 System Schematic

